



### Countertop Commercial Gas Charbroiler

Model	Burners
IRRB-24	2
IRRB-36	3
IRRB-48	4

#### STANDARD FEATURES

##### Construction

- Stainless steel front, sides, and back splash
- 4" high backsplash and sidesplash fully welded to the broiler
- 4" adjustable non skid stainless steel legs
- Removable, easy to clean full width stainless grease catch pan
- Removable, easy to clean grates and radiants

##### Broiler Features

- Heavy-duty 10 gauge stainless steel radiants for consistent heat distribution and non-clog burner protection.
- Heavy-duty cast iron cooking grates, reversible to offer thick or thin char marks with 3 height positions
- Extended cool to touch front edge
- High performance and efficient stainless steel burners giving off 30,000 BTU/burner
- U-style burners provide flame every 6" on the charbroiler grates

##### Control

- Large temperature knobs with set screws
- Individual pilot lights with front access
- LPG conversion kit included
- Warranty: 1 year parts and labor

#### SPECIFICATIONS

The Iron Range Gas Charbroiler radiates heat with efficient 12" U shaped burners that offer a high broiler flame every 6". This gives you flexibility and consistent heat distribution. Temperature controls every 12". Iron Range Charbroilers are available in 24", 36" and 48" widths and are covered with complete parts and labor 1-year warranty.

Units are shipped for natural gas but are easily converted to LPG (propane) gas with the LPG conversion kit that is included.

All Charbroilers carry ETL approval for gas and sanitation that pass USA requirements for use in food service.





## IMPORTANT INFORMATION:

- A convertible pressure regulator is provided with this unit.  
Natural Gas 4.0" (102 mm) W.C.  
Propane Gas 10.0" (279 mm) W.C.
- Gas connection is 3/4" NPT (19mm) rear gas connection is required.
- All equipment is supplied for Natural Gas, an LPG conversion kit is also provided.

All Units

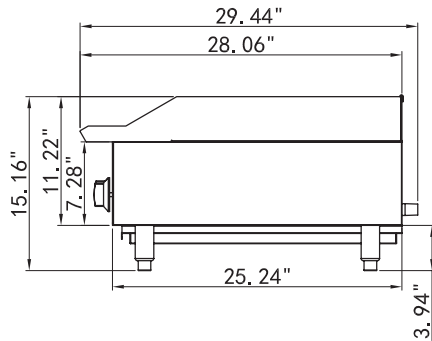

IRRB-24

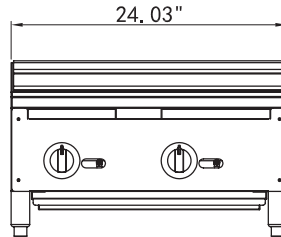

IRRB-24

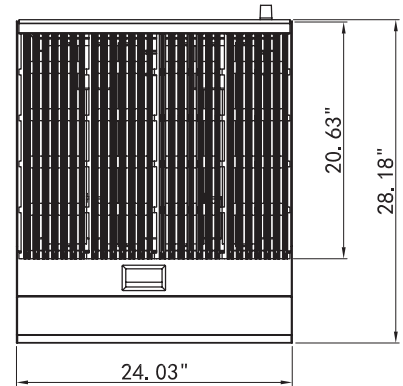

IRRB-36

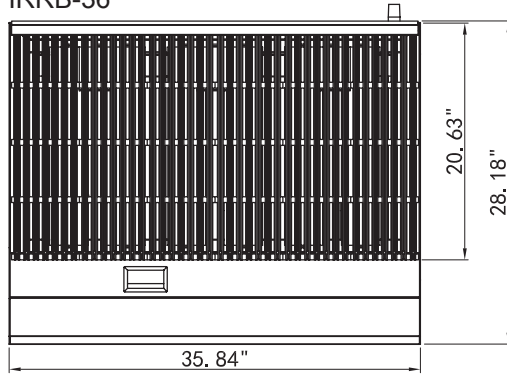

IRRB-36

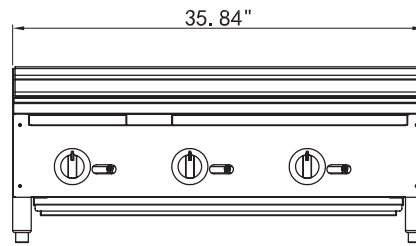

IRRB-48

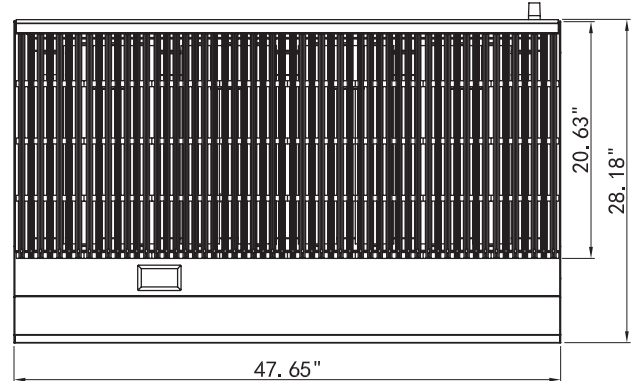

IRRB-48

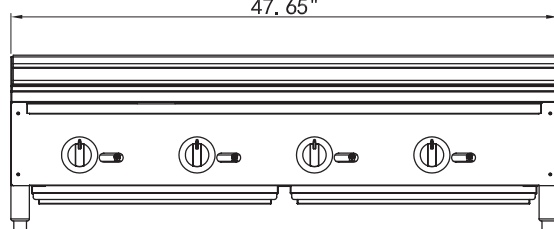

Model	Burners	Cooking Area		Controls	Dimensions			BTU's (per burner)	Total BTU's	Crated Weight (lbs)
		L	W		W	D	H			
IRRB-24	2	20.25	23.5	Manual	24.03	29.44	15.16	35,000	70,000	150
IRRB-36	3	20.25	35.5	Manual	35.84	29.44	15.16	35,000	105,000	218
IRRB-48	4	20.25	47.5	Manual	47.65	29.44	15.16	35,000	140,000	292

Specifications are subject to change without notice.